



ACCESSORIES

FLANGES, BRACKETS, MEASURING WHEELS &
FLEXIBLE COUPLINGS

CONNECTORS

CON-015	Material	Plastic
	Pins	3+GND
	Length	1.3"
	Protection	IP 65



CON-003 (12 Pin) CON-005 (16 Pin)	Material	Brass
	Pins	12 or 16
	Length	2.4"
	Protection	IP 65



CON-012	Material	Brass
	Pins	5
	Length	2.5"
	Protection	IP 40



CON-000	Material	Plastic/Metal
	Pins	9
	Length	2.0"
	Protection	IP 40



CON-007 (6 Pin) CON-009 (7 Pin)	Material	Aluminium
	Pins	6 or 7
	Length	1.3"



MEASURING WHEELS

Type	Circumference	Material	D	B
VGM 201	200 mm	Smooth Plastic	6 mm	12 mm
VGM 202	200 mm	Ribbed Plastic	6 mm	12 mm
VGM 203	200 mm	Aluminium	6 mm	15 mm
VGM 501	500 mm	Aluminium	12 mm	25 mm
VGM 503	500 mm	Smooth Plastic	12 mm	25 mm
VGM 504	500 mm	Ribbed Plastic	12 mm	25 mm

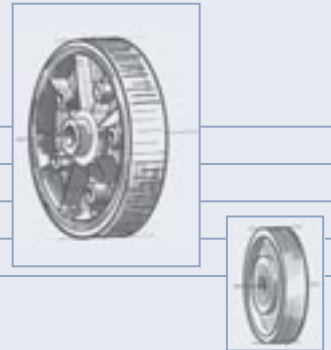

D: Ø Shaft/Bore
B: Surface Width

FLEXIBLE COUPLINGS

Bellows Coupling	Type	VGK 3520
	A	35
	B	20
	C	6-14

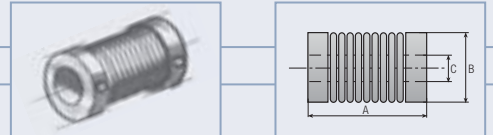

Precision Coupling	Type	VGK 2525
	A	25
	B	25
	C	12

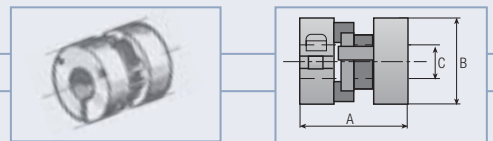

Spring Coupling	Type	VGK 5028	VGK 3516
	A	50	35
	B	28	16
	C	6-24	6-12

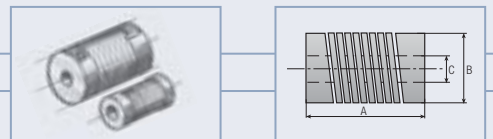

SQUARE FLANGES (IS 581)

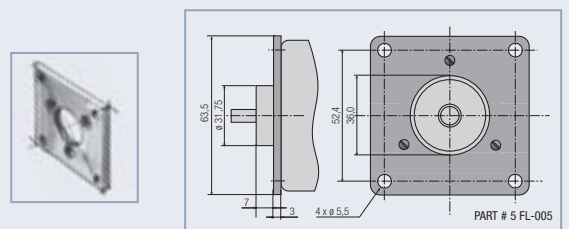



ROUND FLANGES (IS 581)



FLA-002

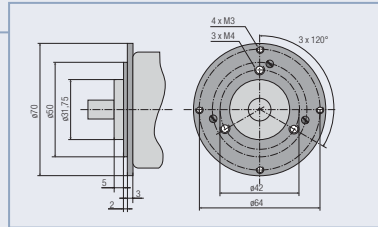

FLA-003

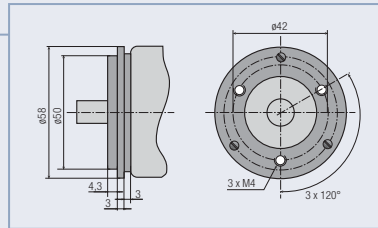

FLA-004

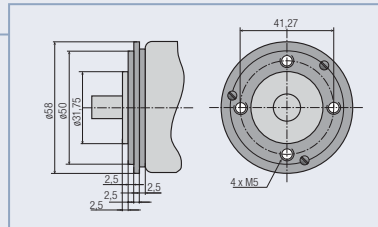

MOUNTING BRACKETS

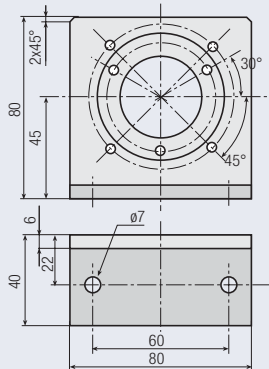

MBR-001 for Series
IS 580/581 & AS 580

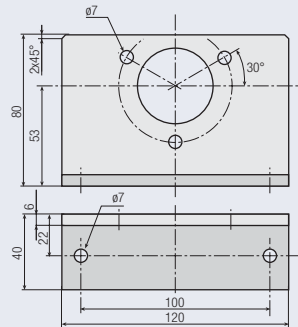

MBR-002 for Series
IS 900 & AS 900

other flanges and accessories available on request